

T81H
Quick Reference
DRAFT - 13 Sep 2016

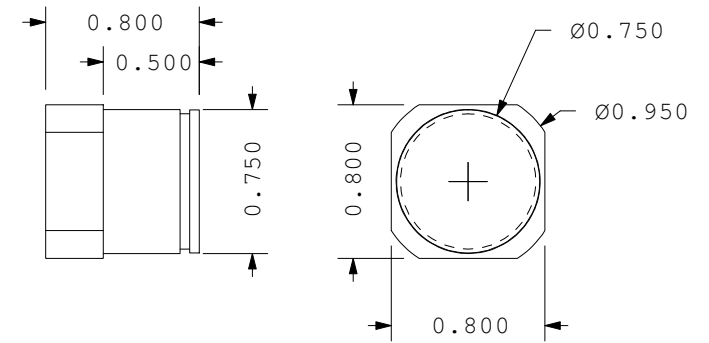

Marking

Inch
Up - On/1
Down - Off/0
Binary
1/16 in

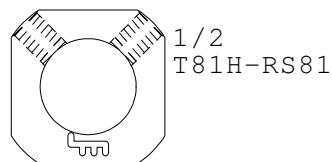
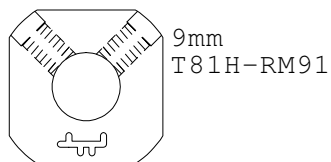
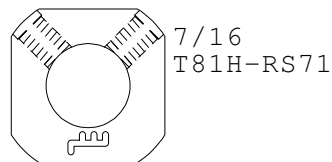
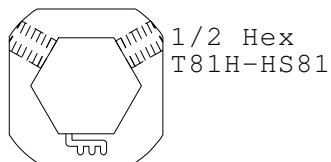
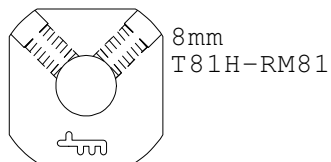
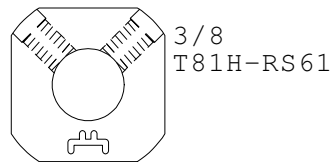
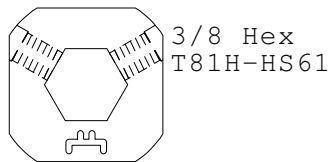
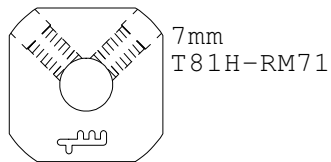
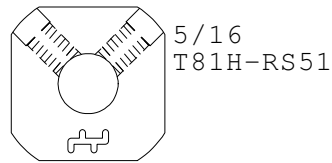
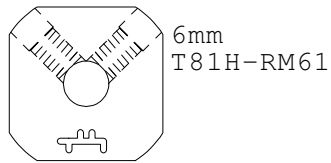
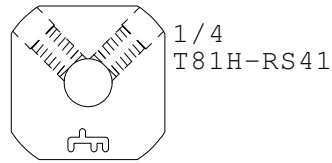
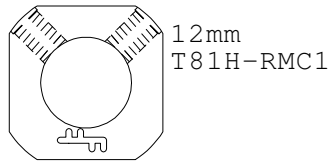
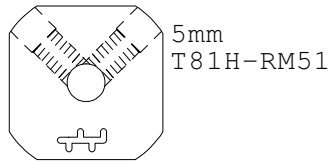
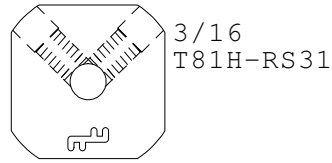
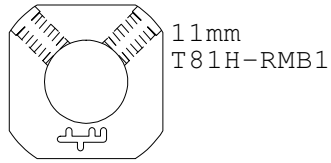
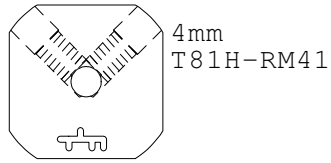
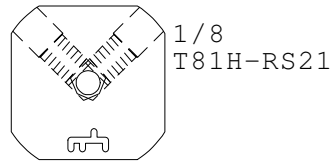
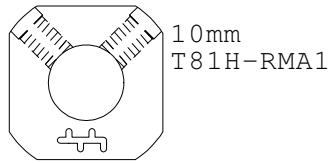
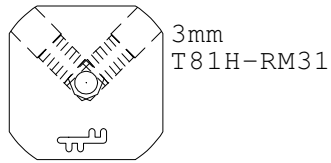
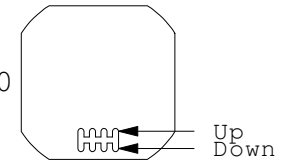

Metric
Up - On
Down - Off
Binary
mm

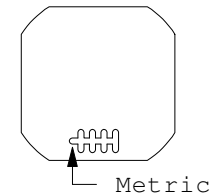

Stock Part Number:

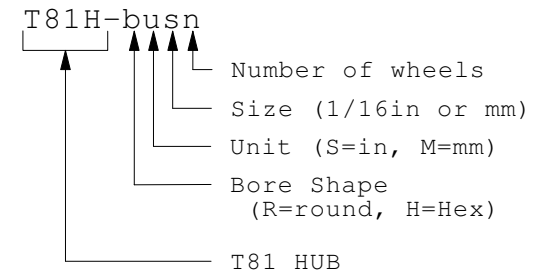

Important Note:

Set Screw Holes are not fully threaded, they are oversized to the threads
Hubs are designed so that the bore can be increased by upto 1mm